

ORION

Includes **MILCOM HYBRID** Technology

Experience the **MILCOM HYBRID** difference: The ORION buttstock fits flawlessly on both Mil-Spec and Commercial-Spec buffer tubes across all tolerances, delivering completely wobble-free performance

STOCK DIAGRAM

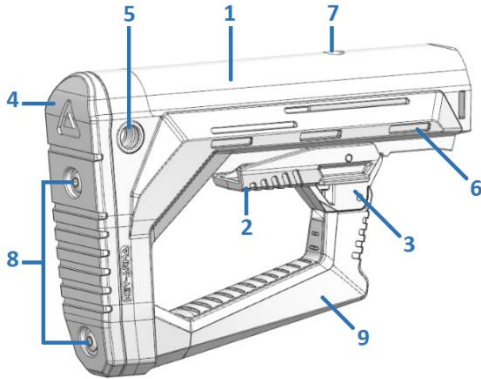

1. Buttstock
2. Buttstock locking button
3. Buttstock functioning mechanism
4. Buttstock pad
5. QD cup for quick-detachable sling swivel (QD)
6. Slots for cheek riser installation
7. Buttstock position indicator
8. Buttstock fixing screws
9. Buttstock handle

How to Install

WARNING: Make sure the firearm is unloaded before installation.

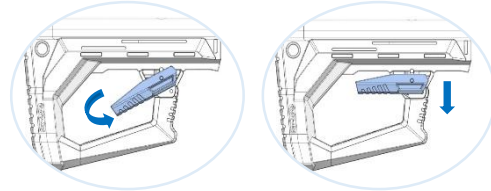
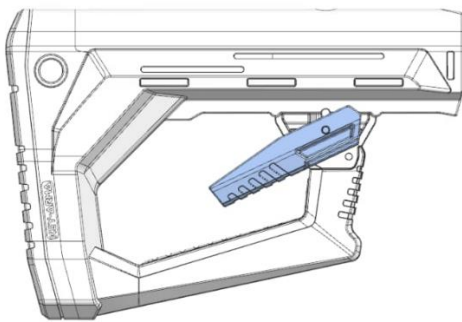

1. Pull down the installation button (2) as it is shown on the pictures.

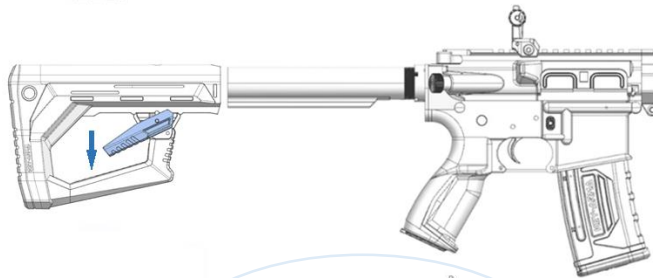

2. While holding the button (2) down, insert the buffer tube inside the stock. The buffer tube must pass through the buttstock functioning mechanism (3). Then, release the button (2).

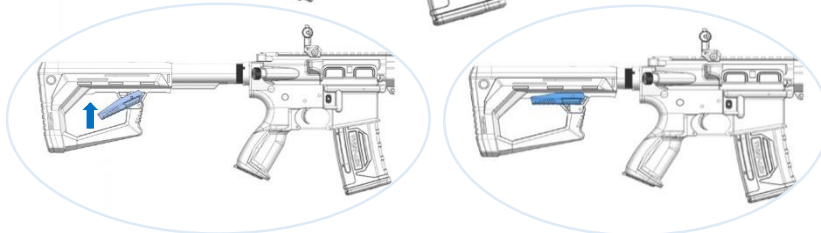

Adjusting the buttstock

Lightly press the buttstock lock button (2) and extend the buttstock to the required length. Then, release the button.

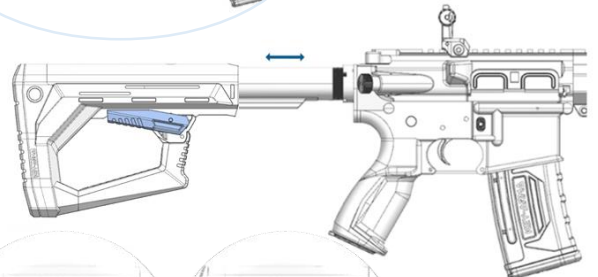

Note:

The installation button (2) has dual mounting options as shown on the pictures

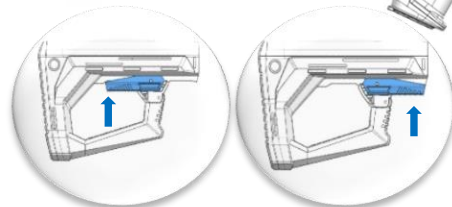

KEY-ARMA

ORION	Length	Width	Height
Dimensions	18.97 cm	5.12 cm	12.86 cm
Weight	300 gr		

TECHNICAL DIMENSIONS

